



# COOK



## CPS

**Flat Blade Centrifugal Blower  
Clockwise Top Horizontal  
Arrangement 10, Class I**

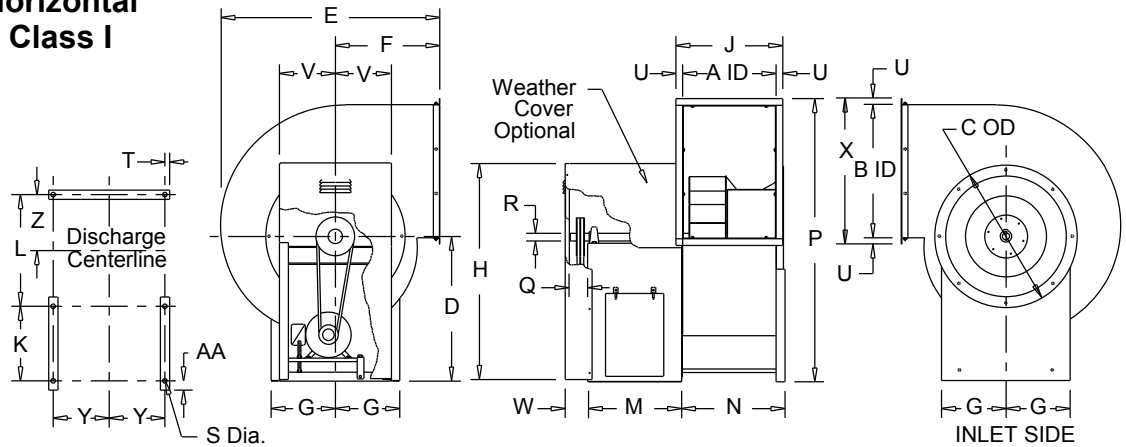

### Performance

Catalog Number	Flow (CFM)	SP (inwc)	Fan RPM	Power (KW)	FEG
150 CPS	2800	1.00	1794	1.01	85

Altitude (ft):0 Temperature (°F):70

### Dimensions (inches)

A	11-7/16	K	12	U	1-5/8
B	16-7/16	L	14-1/8	V	8
C	19-1/8	M	15-1/8	W	4
D	19-1/16	N	13-1/4	X	19-5/8
E	29-5/8	P	36-15/16	Y	8-5/8
F	15-5/16	Q	3	Z	6-9/16
G	9-3/8	R	1		
H	29-1/16	S	9/16		
J	14-5/8	T	3/4		

NOTE: Accessories may affect dimensions shown.

Weight(lbs)***	Shipping	339	Unit	230
----------------	----------	-----	------	-----

\*\*\*Estimate only - Includes fan and motor. Does not include accessories.

### Sound Data Sound Power by Octave Band

	1	2	3	4	5	6	7	8	LwA	dBA
Inlet	75	79	83	80	74	74	73	67	84	73
Outlet	87	83	85	82	77	76	72	66	82	71

Loren Cook Company certifies that the CPS shown herein is licensed to bear the AMCA Seal. The ratings shown are based on tests and procedures performed in accordance with AMCA Publication 211 and AMCA Publication 311 and comply with the requirements of the AMCA Certified Ratings Program.

Performance certified is for installation type B: free inlet, ducted outlet. Power rating (BHP/kW) does not include transmission losses. Performance ratings do not include the effects of appurtenances (accessories). The sound power level ratings shown are in decibels, referred to 10(-12) watts calculated per AMCA Standard 301. Values shown are for inlet Lwi and LwiA sound power levels for installation type B: free inlet, ducted outlet. Ratings do not include the effects of duct end correction. The A-weighted sound ratings shown have been calculated per AMCA Standard 301. The dBA levels shown have been calculated for a distance of 5 ft in a hemispherical free field.

### Fan Curve Legend

CFM vs SP	—
CFM vs KW	—
Point of Operation	○
System Curve	- - -
Do Not Select	—

